



# Bevelling system B10 ELECTRA

Maximum bevel width 10 mm / 0.4 in. Edge rounding function.

# B10 Electra

High Performance  
Motor and Gearbox



Art. Nr. 25300 (1 Phase - 220 V)  
Art. Nr. 25301 (1 Phase - 110 V)





**Designed for beveling and deburring workpieces, internal and external radiuses and holes. Specially designed for producing bevels and welding preparation. Durable and stable machine design without compromises. Thanks to the special design of the cutting head you will you save ½ inserts at reductions of up to 8 mm / 0.31 in of the bevel width.**

- Scale for an accurate bevel size adjustment
- For beveling and deburring steel, aluminum and other materials
- Replaceable head for changing bevel angle
- Handheld powerful equipment
- Electronic Speed Control
- Edge rounding function, preparation before surface treatment

**Technical data:**

Bevel angle: replaceable head 30°, 37,5°, 45°, 50°, 60°- other angles on demand  
 Bevel width: 0 to 10mm / 0 to 0.4 in < 400 MPa / 58 015 PSI  
 0 to 5mm / 0 to 0.2 in > 400 MPa / 58 015 PSI  
 Rounding app: R 2,5 mm, R 3,5 mm, R 4 mm / R 0,1 in, R 0,14 in, R 0,16 in  
 Engine: 1700 W  
 Speed: 2700 - 8 500 rpm  
 Overload protection: thermal  
 Feed: manual  
 Weight: 6 kg / 13.2 lb

**Included in price:**

Beveling and deburring system B10 ELECTRA (without the head).  
 Tools for an operator.  
 Packed in a cardboard box.  
 User manual.

Machine name:	Art. Nr.
The B10 ELECTRA beveling and deburring system (1 Phase - 220 V)	25300
The B10 ELECTRA beveling and deburring system (1 Phase - 110 V)	25301

Accessories:	
Milling heads	see page 14-15
B-Dock (Beveler B10 Electra is not included)	see page 16-17 (and price advantage sets page 20-21)
Xpipe Beveler (Beveler B10 Electra is not included)	see page 18-19 (and price advantage sets page 20-21)
Edge Cleaner	see page 14
Special lubricating paste for the milling heads. Prevents seizing up, wear, cold-welding, solidifying of the threads 120g.	Art. Nr. 33005
Universal tube key (for milling head´s removing)	Art. Nr. 25300.27



Xpipe Beveler



B-Dock



Edge Cleaner



Cutting inserts



Milling heads



Rounding milling heads



Cutting inserts



























Universal tube key



### The Premium milling heads for processing tougher materials.

- For B10 Electra, B15 Electra and B15 AIR hand held bevelers
- Developed especially for stainless steel and other tougher materials
- More effective increased safety
- Smoother final surface and higher lifetime for the cutting inserts
- Longer cutting inserts (15 mm/0.6") are standard and two-sided
- Shorter cutting inserts (8 mm/0.3") are four-sided » double lifetime

Required bevel angle	The starter kit Premium milling head max 15 mm/0.6" two sided cutting inserts	The spare two sided cutting inserts 15 mm/0.6"	The additional special roller for shorter cutting inserts 8 mm/0.3" (the milling head stays original)	The shorter four sided cutting inserts 8 mm/0.3"	The fastening screws for the cutting inserts (works with both cutting inserts versions)
30°	 <b>Art. Nr. 27223X</b> (the cutting inserts and the lead roller Ø 30 mm / 1.19" are included)	 <b>Art. Nr. 28015</b> (10pcs package)	 <b>Art. Nr. 28004</b> (complete special lead roller Ø 33,5 mm / 1.32" for shorter cutting inserts)	 <b>Art. Nr. 28008</b> (10pcs package)	 <b>Art. Nr. 28007</b> (1pc)
37.5°	 <b>Art. Nr. 27227X</b> (the cutting inserts and the lead roller Ø 26 mm / 1.02" are included)	 <b>Art. Nr. 28015</b> (10pcs package)	 <b>Art. Nr. 28013</b> (complete special lead roller for shorter cutting inserts)	 <b>Art. Nr. 28008</b> (10pcs package)	 <b>Art. Nr. 28007</b> (1pc)
45°	 <b>Art. Nr. 27222X</b> (the cutting inserts and the lead roller Ø 26 mm / 1.02" are included)	 <b>Art. Nr. 28015</b> (10pcs package)	 <b>Art. Nr. 28005</b> (complete special lead roller Ø 31 mm / 1.23" for shorter cutting inserts)	 <b>Art. Nr. 28008</b> (10pcs package)	 <b>Art. Nr. 28007</b> (1pc)
50°	 <b>Art. Nr. 27224X</b> (the cutting inserts and the lead roller Ø 26 mm / 1.02" are included)	 <b>Art. Nr. 28015</b> (10pcs package)	 <b>Art. Nr. 28014</b> (complete special lead roller for shorter cutting inserts)	 <b>Art. Nr. 28008</b> (10pcs package)	 <b>Art. Nr. 28007</b> (1pc)
60°	 <b>Art. Nr. 27240X</b> (the cutting inserts and the lead roller Ø 19 mm / 0.75" are included)	 <b>Art. Nr. 28015</b> (10pcs package)	 <b>Art. Nr. 28006</b> (complete special lead roller Ø 25,5 mm / 1.01" for shorter cutting inserts)	 <b>Art. Nr. 28008</b> (10pcs package)	 <b>Art. Nr. 28007</b> (1pc)

### Edge Cleaner - grinding adapter





Edge Cleaner - grinding adapter (including 10pcs grinding rings grain 40, 1pc guiding roller)	Grinding rings, grain 40 (pack 50pcs)	Spare polyurethane guiding roller
 <b>Art. Nr. 25310</b>	 <b>Art. Nr. 25312</b>	 <b>Art. Nr. 25311</b>

# Milling Heads and other accessories for B10 Electra, B15 Electra and B15 Air



## The Rounding milling heads

- For B10 Electra, B15 Electra and B15 AIR hand held bevelers
- Smoother final surface and higher lifetime for the cutting inserts
- For edge rounding application

Required radius	Complete radius milling head, including of the guiding roll and fastenin screw	Radius 4 - sided cutting inserts	The fastening screws for the cutting inserts
R 2.5 mm / 0.08 in	 <p><b>Art. Nr. 27234</b> (the cutting inserts and the lead roller Ø 40 mm / 1.58" are included)</p>	 <p><b>Art. Nr. 26109</b> (10pcs package)</p>	 <p><b>Art. Nr. 27242</b> (1pc)</p>
R 3.5 mm / 0.12 in	 <p><b>Art. Nr. 27233</b> (the cutting inserts and the lead roller Ø 40 mm / 1.58" are included)</p>	 <p><b>Art. Nr. 26110</b> (10pcs package)</p>	 <p><b>Art. Nr. 27242</b> (1pc)</p>
R 4 mm / 0.16 in	<p>Compatible with the milling head R 3.5 mm / 0.12"</p> <p><b>Art. Nr. 27233</b></p>	 <p><b>Part no. 26111</b> (10pcs package)</p>	 <p><b>Part no. 27242</b> (1pc)</p>

## The older ECO milling heads. Available while supplied last.

	Art. Nr.
30° cutting head (including inserts, screws, bolts and roller). Guide roller diameter Ø 34 mm / 1.34 in	27223
37.5° cutting head (including inserts, screws, bolts and roller). Guide roller diameter Ø 28 mm / 1.10 in	27227
45° cutting head (including inserts, screws, bolts and roller). Guide roller diameter Ø 28 mm / 1.10 in	27222
50° cutting head (including inserts, screws, bolts and roller). Guide roller diameter Ø 28 mm / 1.10 in	27224
60° cutting head (including inserts, screws, bolts and roller). Guide roller diameter Ø 27 mm / 1.06 in	27240
Coated cutting inserts - four-sided (pack of 10 pcs)	27231
Screw for the inserts	27241

## Lubricating paste

	Art. Nr.
Special lubricating paste for the milling heads. Prevents seizing up, wear, cold-welding, solidifying of the threads 120g.	33005



Art. Nr. 27223



Art. Nr. 27231



Thousands of satisfied customers throughout the world



**Xpipe Beveler (accessory for B-Line Machines)**  
Maximum bevel width 15 mm / 0.6 in. (10mm / 0.4 in.)  
Edge rounding function.

# *Xpipe Beveler*

## *Compatible with B10 Electra, B15 Electra and B15 Air*

Ergonomic, rotating handle  
increases work productivity

The bevel depth can be set  
continuously

Lightweight aluminum construction  
of the machine frame

Special one-way bearings for the roller  
shutters prevent any kickback

The Beveling Machine  
is not included with  
Xpipe Beveler

Art. Nr. 25500



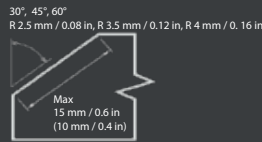

**Bevelling tool for easy and fast machining of pipes from Ø 85 mm (3.36").**  
**The maximum diameter of the pipe is not limited, and the tool can be used on flat materials.**  
**The unique mechanism of clamping, guiding rollers ensures precise and comfortable guiding around the circumference of the machined pipe or along the edge of the sheet metal.**  
**The robust frame of the body guarantees constant cut with a minimum of possible vibrations and uncompromising stability of the selected bevel angle.**

- Designed to work with B10 Electra, B15 Electra and B15 AIR bevelling machine
- Continuous bevel depth settings built-in scale
- Special one-way bearings preventing kickback of approaching material, safe and comfortable beveling
- The set removal value can be ensured, and a constant chamfer depth can be guaranteed even on a larger number of pipes
- Unique, flexible mounting of the running rollers, suitable for any unevenness and inaccuracies around the circumference of the pipe
- Lightweight aluminum construction of the machine frame guarantees comfortable handling of the product
- Ergonomic, rotating handle for productivity and safety
- Safety cover for flying chips, preventing possible injuries

**Technical data:**

Bevel angle:	30°, 45° and 60°
Bevel width:	10 mm / 0.39" (with B10 Electra) 15 mm / 0.60" (with B15 Electra and B15 AIR)
Rounding app:	R 2,5 mm / R 0.10", R 3,5 mm / R 0.137", R4 mm / R 0.157"
Minimum ID (outside machining):	> Ø 85 mm / 3.36"
Wall thickness (outside machining):	2,5 - 15 mm / 0.10" - 0.60"
Minimum ID (inside machining):	> Ø 500 mm / 19.7" (smaller Ø on request)
Wall thickness (inside machining):	5 - 15 mm / 0.20" - 0.60"
Minimum clamping depth:	80 mm / 3.15"
Thickness working (flat bevelling):	3 - 20 mm / 0.11" - 0.78"
Feeding:	manual
Weight (without the machine):	8,4 kg/18.5 lb.

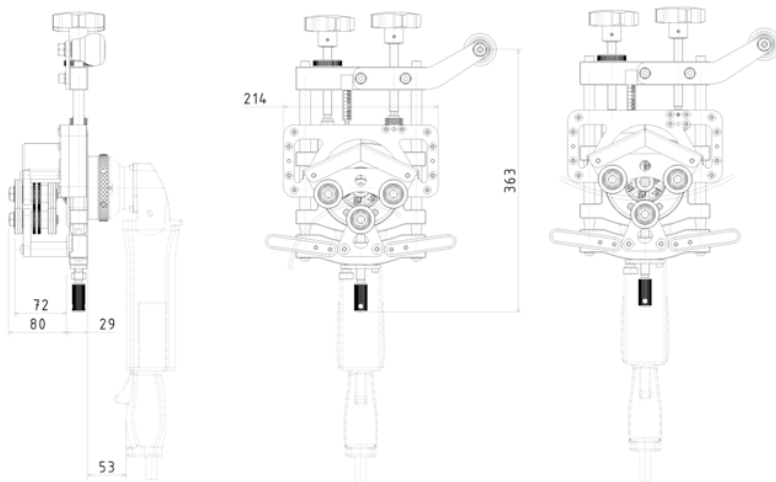

**Included in price:**

- Xpipe Beveler (without bevelling machine)
- Tools for an operator
- Packed in a cardboard box
- User manual

**Cost effective sets, see page 20-21**

**Machine name:**

The Xpipe Beveler (without bevelling machine)

**Art. Nr.**

25500



# B-Dock

## Compatible with B10 Electra and B15 Electra

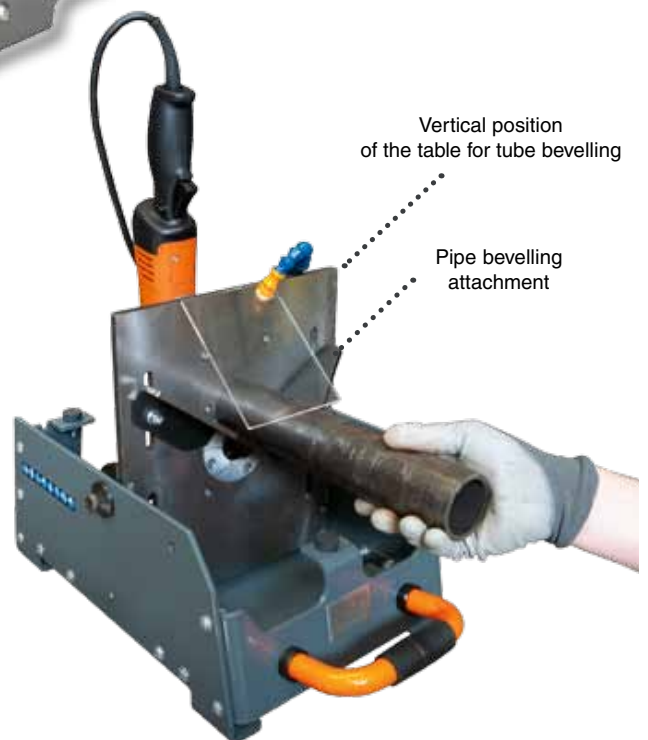
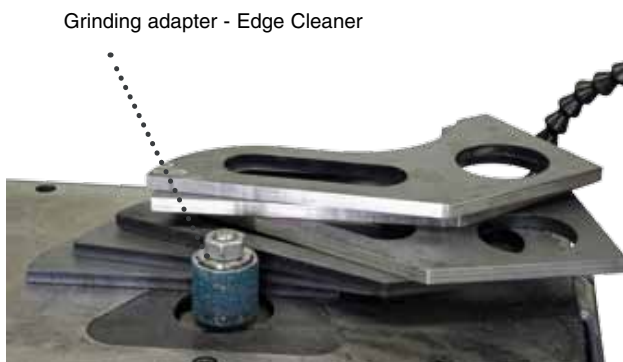

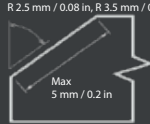

Dock station B-Dock enables the B-Line Machine (B10, B15 Electra) to be used stationary. It is designed for beveling small workpieces which would be hard or impossible to clamp and bevel the standard way. The system retains all advantages of the hand-held B-Line Machines (B10, B15 Electra). The B-dock system makes it possible to bevel irregular shapes, straight workpieces and holes. Radiused edges are also possible with the radius milling head. Specialty guide attachments and an easy, vertical worktable adjustment allow for beveling of pipe and tube.

By purchasing the set B-Dock + B10 or B15 Electra you are getting a universal beveling system.

- Tilting table for easy attachment of B10, B15 Electra
- Vertical position of the table for convenient pipe beveling
- Straight edge and pipe guide attachments included in the price
- Adjustable protection shield increases work safety
- Robust design for precision beveling and durability of the B-dock
- The Hardox work surface is wear resistant
- Light weight system is easy to transport
- Can be used with B15 Electra or B10 Electra machines

**Technical data:**

Bevel angle: see previous page (technical date for B10, B15 Electra)  
 Bevel width: 0 to 5mm / 0 to 0.2 in  
 Rounding app: see previous page (technical date for B10, B15 Electra)  
 Motor: see previous page (technical date for B10, B15 Electra)  
 RPM: see previous page (technical date for manual)  
 Feed: manual  
 Weight: 28kg / 62 lb  
 Dimensions: 443 x 368 x 220mm / 17,5 x 14,5 x 8

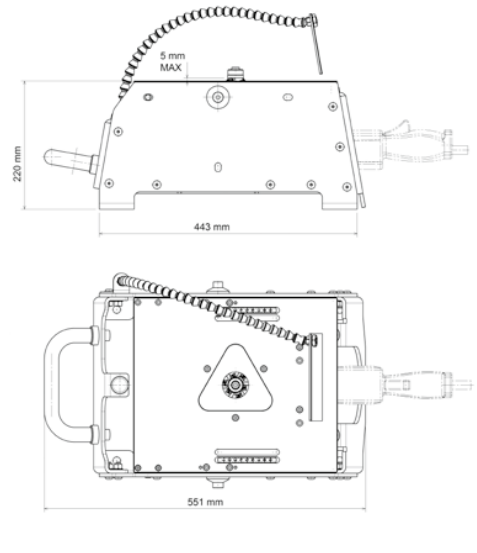

**Included in price:**

- Dock station B-dock (without bevelling machine)
- Tools for an operator
- Packed in a cardboard box
- Manual

**Machine name:**

The Beveling System B-Dock (without bevelling machine)	<b>Art. Nr.</b> 25350
--------------------------------------------------------	--------------------------

**Accessories:**

Head cover for radius heads	<b>Art. Nr.</b> 25350.6RT
Protection felt plug (for B10 Electra only)	25315

*Cost effective sets, see page 20-21*



Pipe bevelling attachment



Straight edge bevelling guide



Protection felt plug



Head cover







# ***B-Line sets!***

## ***Compactible accessories for B10 Electra, B15 Electra and B15 Air***







Cost effective accessories sets for B10 Electra, B15 Electra and B15 Air.





These accessories will transform your B-line into a versatile tool, which can handle most of your future projects.

You can bevel flat steel, or tubes, small workpieces or you can do rounding of the plate edges. All in one solution!

<i><b>B10 Electra sets</b></i>	<b>Set 230V</b>	<b>Set 120V</b>
 <p>B10 Electra + B-Dock</p>	Art. Nr. 25302	Art. Nr. 25303
 <p>B10 Electra + Xpipe Beveler</p>	Art. Nr. 25304	Art. Nr. 25306
 <p>B10 Electra + B-Dock + Xpipe Beveler</p>	Art. Nr. 25305	Art. Nr. 25307



<b>B15 Electra sets</b>		<b>Set 230V</b>	<b>Set 120V</b>	
 B15 Electra	 B-Dock	Art. Nr. 25252	Art. Nr. 25253	
 B15 Electra	 Xpipe Beveler	Art. Nr. 25254	Art. Nr. 25256	
 B15 Electra	 B-Dock	 Xpipe Beveler	Art. Nr. 25255	Art. Nr. 25257

<b>B15 Air sets</b>		<b>Pneumatic powered</b>
 B15 Air	 Xpipe Beveler	Art. Nr. 27225
 B15 Air - S	 Xpipe Beveler	Art. Nr. 27225S