

UZ50 Triumph



3D adaptive system

**3 BEVELERS
IN ONE**



Cutter powerful motor - 4000 W

Remote control can be operated hand-held or clamped to the machine

Quick connect machine system

Rotary mechanism allows to perform two-sided bevelling without a need for material handling

Height adjustment of the machine position.

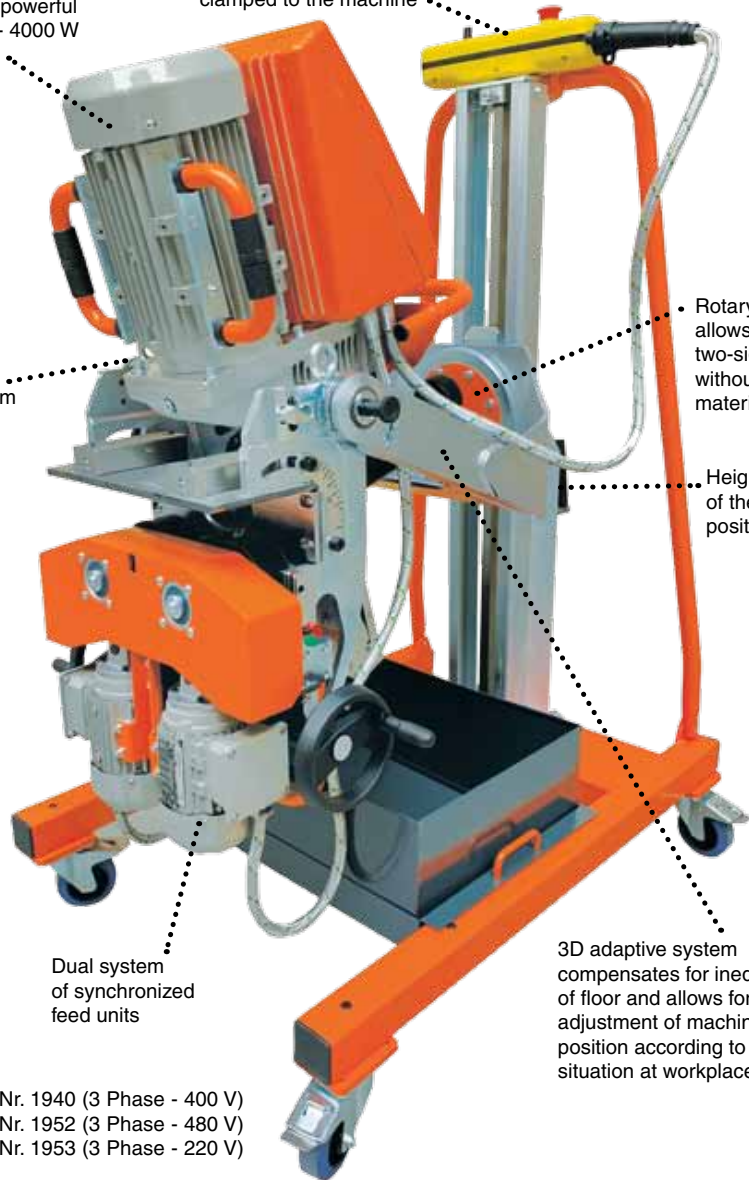

Dual system of synchronized feed units

3D adaptive system compensates for inequality of floor and allows for the adjustment of machine position according to the situation at workplace

Art. Nr. 1940 (3 Phase - 400 V)
Art. Nr. 1952 (3 Phase - 480 V)
Art. Nr. 1953 (3 Phase - 220 V)





Bevelling system UZ 50 Triumph is another of the series of unique solutions developed N.KO Machines. Basically, three bevelling systems are combined in a single machine. UZ50 Triumph can be used as a mobile beveller, which moves along the beveled material at the speed up to 1.2m/min, 3.93 ft/min. The range of the beveling angle is 15°-50°. In addition, it is possible to flip the entire machining unit upside down and create bevels for X and K form of the welds without handling machined material. This application is made possible by the rotary mechanism of the 3D manipulator, which is a standard machine equipment. Finally, the machine can be rebuilt for a stationary beveller with a special equipment UZP 30. This mode is intended for processing smaller parts with a minimum length of the bevel edge 200mm, 8.19 in.

Adjustable cutting conditions enable the UZ50 to machine otherwise difficult materials like stainless steel, Hardox (armored steel), Weldox and Domex on top of mild carbon steel.

3D manipulator allows to adapt UZ50 for any unevenness or deformations in the length of machined material. It also allows to work on uneven floor.

If needed it is possible to disconnect the UZ50 from the manipulator completely due to the quick-connect function within few seconds and use the UZ50 separately.

- Automatic feed with continuous adjustment of the feed rate in the range of 0 - 1,2 m/min. / 0 - 3.93 ft/min
- High speed milling tool equipped with cutting inserts with extended life
- The variable adjustment of the desired angle in the range 15°-60 ° without having to replace any parts
- All electronic equipment is closed in the dust-tight cabinet with increased vibration resistance
- Equipped with the most modern safety features
- The possibility to buy ASP – active smart protection
- The machine cuts problematic materials - e.g., stainless steel, Hardox, Weldox a Domex

Technical data:

Max. bevel width:	62 mm / 2.44 in
Adjusting the bevel angle:	15° - 60° (continuous)
Material thickness:	7 to 80 mm / 0.27 to 3.15 in
Motor of cutting head:	4000 W
Feed speed:	0 - 1,2 m/min. / 0 - 3.93 ft/min.
Weight:	175 kg / 385.8 lb
Dimensions:	1010 x 745 x 1326 mm
	39.76 x 29.33 x 52.2 in
Number of cutting inserts	5 pcs

Included in the price:

- Bevelling system UZ50 TRIUMPH.
- Tools for an operator.
- Packed in a wooden crate.
- User manual.

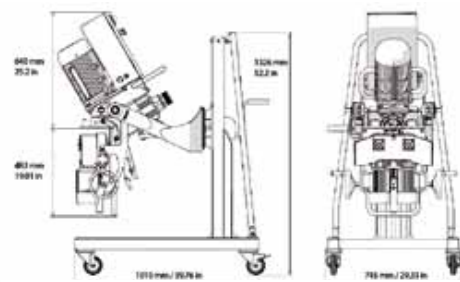

bevel angle Q

max. width of the bevel (P)

15°	62 mm / 2.44 in (recommended in 3 passes)
20°	62 mm / 2.44 in (recommended in 4 passes)
25°	56 mm / 2.2 in (recommended in 4 passes)
30°	52 mm / 2.04 in (recommended in 5 passes)
35°	51 mm / 2 in (recommended in 5 passes)
40°	51 mm / 2 in (recommended in 5 passes)
45°	50 mm / 1.97 in (recommended in 5 passes)
50°	51 mm / 2 in (recommended in 5 passes)
55°	51 mm / 2 in (recommended in 5 passes)
60°	52 mm / 2.04 in (recommended in 5 passes)

B=max. 5 mm / 0.2 in (1 pass)

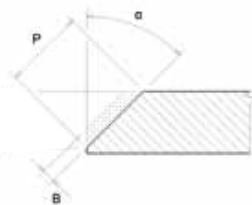

Machine name:

	Art. Nr.
Bevelling system UZ50 TRIUMPH - including 3D manipulator (3 Phase - 400 V)	1940
Bevelling system UZ50 TRIUMPH - including 3D manipulator (3 Phase - 480 V)	1952
Bevelling system UZ50 TRIUMPH - including 3D manipulator (3 Phase - 220 V)	1953

Accessories:

	Art. Nr.
ECO Cutter head 5 inserts (Insert´s screw included)	1946
ECO Cutting inserts (pack of 10 pcs)	1945
PREMIUM Cutting head 9 inserts (Insert´s screw included)	1943
PREMIUM Cutting inserts (pack of 10 pcs)	1955
Plate fence for adjusted for HARDOX bevelling and other wear-resistant materials	1949
ASP active, intelligent machine protection against overload	1956
UZP 30 additional table for processing small pieces	1942
Screw for the inserts	1947

ASP - Active intelligent machine protection against overload

It is a system monitoring immediate machine load and machining conditions.

If the ASP system detects overload of the machine for reasons of tool wear, too high feed rate, or improperly adjusted machine, the ASP system informs the operator of this fact actively by flashing lights on the remote control.

If the operator fails to do steps leading to reduce load on the machine within 20 seconds (resizing removal, replacement of cutting tips, reducing speed), the system disconnects the supply of feed wheels and the machine stops. Beware, the system does not protect against the shock overload! The ASP system is only available for purchase as an accessory with a new machine.



Art. Nr. 1946



Art. Nr. 1943

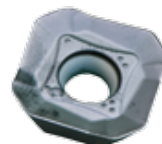

Art. Nr. 1945

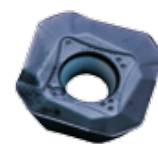

Art. Nr. 1955



Bevelling system UZ50 TRIUMPH + UZP 30 set
 Maximum bevel width 34 mm / 1.33 in. Automatic feed.

UZ50 Triumph

+ UZP30 set



**3 BEVELERS
IN ONE**



Art. Nr. 1941 (3 Phase - 400 V)
 Art. Nr. 1954 (3 Phase - 480 V)
 Art. Nr. 1957 (3 Phase - 220 V)



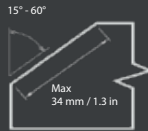

The UZP 30 product allows modification of UZ50 TRIUMPH into the stationary beveling station for processing smaller workpieces or narrow steel strips, it can be purchased separately or in a set with the machine UZ50 TRIUMPH. The UZ50 TRIUMPH with this accessory has all the advantages of UZ50 TRIUMPH. For example machining of harder material such a Hardox, armored steel and etc. But it can also be used for mild carbon steel. The minimum edge length of the bevelled material must be at least 250 mm / 12 in.

- Use with the machine UZ50 Triumph
- The variable adjustment of the desired angle of 20° - 60° without having to replace any parts
- Beveling small size workpieces that are inserted directly into the machine. The whole machining process is then automatic without having to hold the workpiece
- Equipped with the most modern safety features
- Possibility to buy ASP – active smart protection
- Cuts problematic materials - e.g., stainless steel, Hardox Weldox and Domex

Technical data:

Max. bevel width: 34 mm / 1.57 in
 Adjusting the bevel angle: 20° - 60° (continuous)
 Material thickness: 7 to 70 mm / 0.27 to 2.75 in
 Cutting head motor: 4000 W
 Feed speed: 0 - 1,2 m/min. / 0 - 3.93 ft/min.
 Weight: 202 kg / 445 lb
 Dimensions: 1010 x 745 x 1326 mm
 39.76 x 29.33 x 52.2 in
 Number of cutting inserts 5 pcs

Included in the price:

Beveling system UZ50 TRIUMPH + UZP30 set
 Tools for an operator.
 Packed in a cardboard box. (UZ50 TRIUMPH is Packed in a wooden crate).
 User manual.

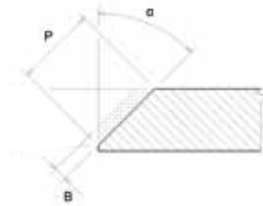

bevel angle α	max. bevel width (P)
20°	11 mm / 0.43 in (recommended in 2 passes)
25°	11 mm / 0.43 in (recommended in 2 passes)
30°	14 mm / 0.55 in (recommended in 2 passes)
35°	18 mm / 0.71 in (recommended in 2 passes)
40°	22 mm / 0.86 in (recommended in 3 passes)
45°	28 mm / 1.10 in (recommended in 3 passes)
50°	31 mm / 1.22 in (recommended in 5 passes)
55°	30 mm / 1.18 in (recommended in 5 passes)
60°	34 mm / 1.33 in (recommended in 5 passes)

B=max. 4mm / 0.15 in (1 pass)

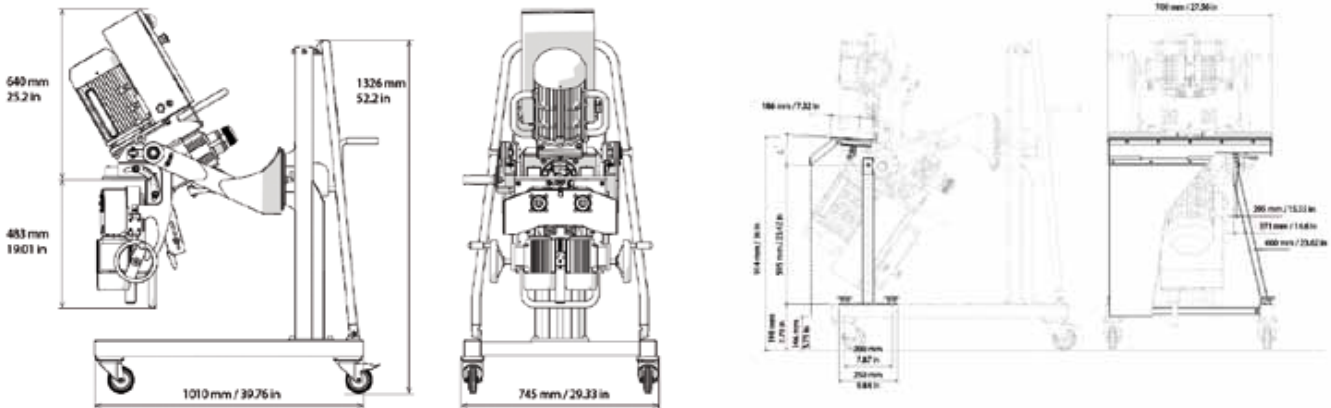

Machine name:

Machine name	Art. Nr.
Beveling system UZ50 TRIUMPH (incl. 3D manipulator) + UZP30 set (3 Phase - 400 V)	1941
Beveling system UZ50 TRIUMPH (incl. 3D manipulator) + UZP30 set (3 Phase - 480 V)	1954
Beveling system UZ50 TRIUMPH (incl. 3D manipulator) + UZP30 set (3 Phase - 220 V)	1957

Accessories:

Accessories	Art. Nr.
PREMIUM Cutting head 9 inserts RECOMMENDED when using UZP30!	1943
ECO Cutting inserts (pack of 10 pcs)	1945
PREMIUM Cutting inserts (pack of 10 pcs)	1955
Vertical guide plate adapted for beveling HARDOX and other wear-resistant materials	1949
ASP active smart protection against overloading of the machine	1956
Screw for the inserts	1947



Art. Nr. 1943



Art. Nr. 1945



Art. Nr. 1955